

Please visit [Jeep.com](http://Jeep.com) for instructional videos.

68196443AA

### Proper strap locations

Figure 1  
4-door, open

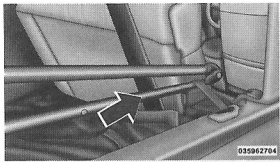

Figure 2  
4-door Sunrider position

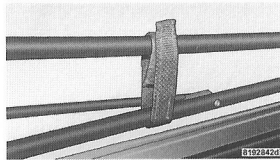
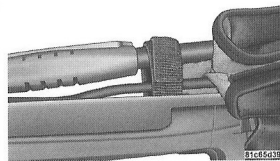
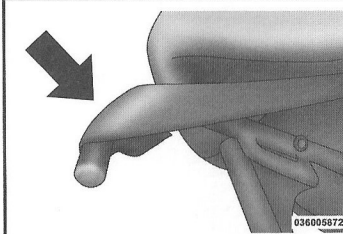

Figure 3  
2-door Sunrider position



### Other Helpful Operation and Usage Tips

- 4 Door - Strap **MUST** be secured to Bracket before removing the top from vehicle. See Owners Manual for complete details.
- Open swing gate when lowering top or raising the top.
- To ease the operation of the soft top, another person will be helpful.
- For Sunrider feature follow steps 1 & 5 ONLY.
- When top is in Sunrider position; you must use the velcro straps to secure the top (as shown in figures 2 & 3).
- Do not remove the door frames or attachment knobs (3 per side) when operating the Sunrider feature.
- Store windows in a safe place to prevent scratching.
- Raise the 4-door top by grabbing both side bows (as shown in Step 7).
- When raising the 2-door top, it may be easier to raise the entire top at once.
- Ensure Sunrider latches (if equipped) are fully engaged when reassembling top.
- Ensure zippers are properly aligned when reassembling top (as shown in Figure 4).



Ensure straps are correctly positioned on cross bows at the front and rear location before securing the rear corners.

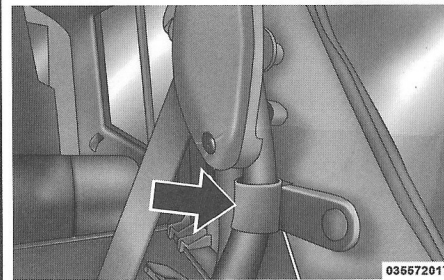

Strap **MUST** be secured to Bracket before removing the top from vehicle.

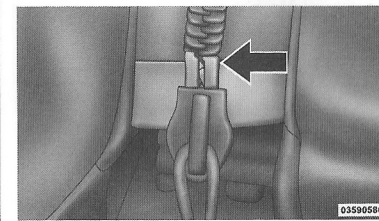
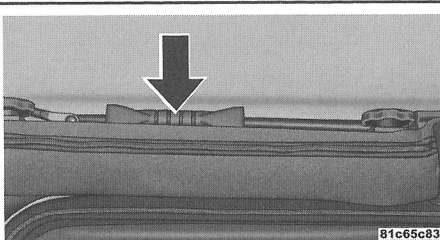
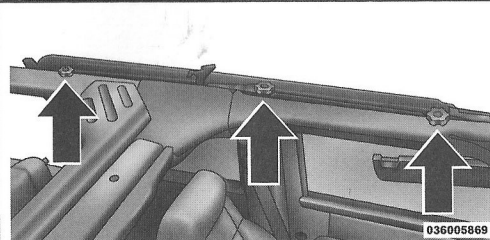

Figure 4  
Ensure rear window and quarter window zippers are properly aligned when reassembling top.



Slide sleeve forward to open 2-door Sunrider (located above both doors).



To remove the door rails, lower the top then remove all three attachment knobs.

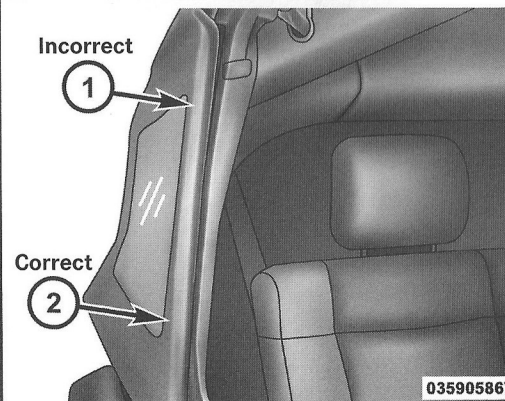

When installing quarter windows, make sure leading edge is fully wrapped into the door rail. (Only one stitch line should be visible).

**Jeep**

Please see Owners Manual for complete details.

**FOR CUSTOMER REMOVAL ONLY!**

**Jeep**

# Instructions to Fold Down the Soft Top

68196443AA

**1** Release the header latches.

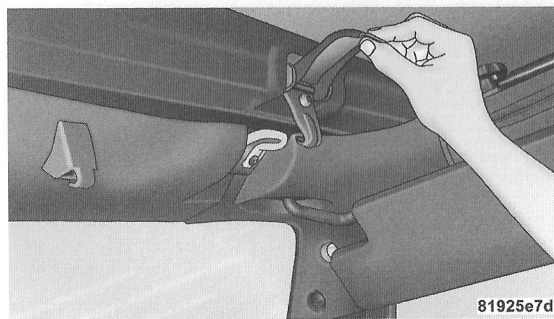

**2** Unzip back window and quarter windows and store in a safe place.

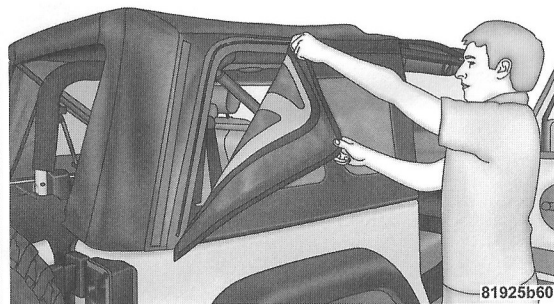

**3** Pull down on rear bow to release lower rear panels.

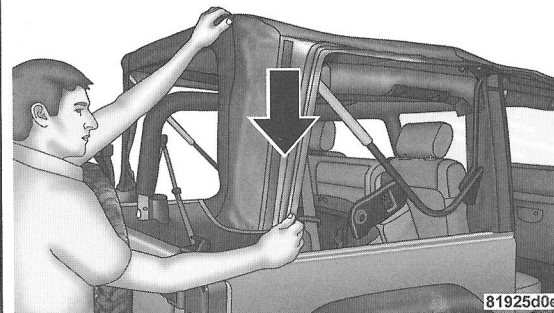

**4** Place rear flaps on top of vehicle.

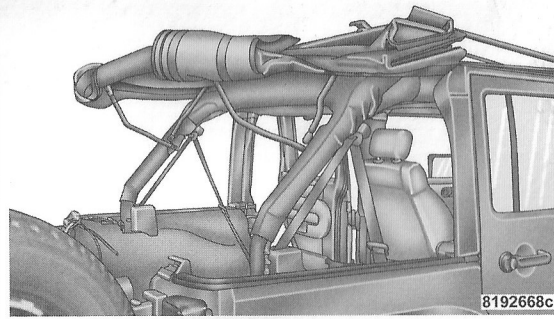

**5** Rotate header rearward. Fold the top material rearward so that the material forms a "W".

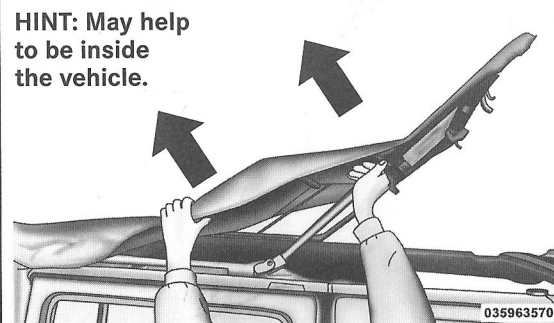

4-Door Only

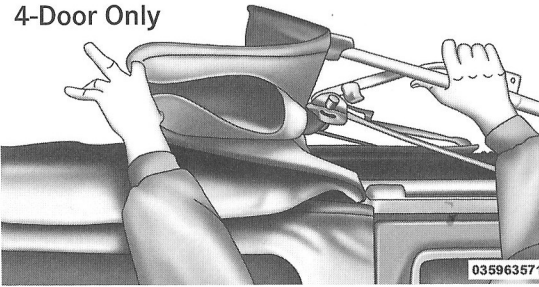

**6** Release Sunrider latch (both sides).

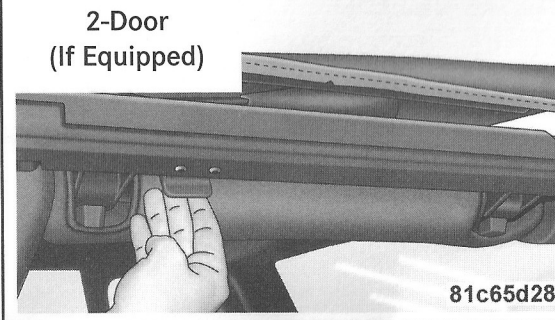
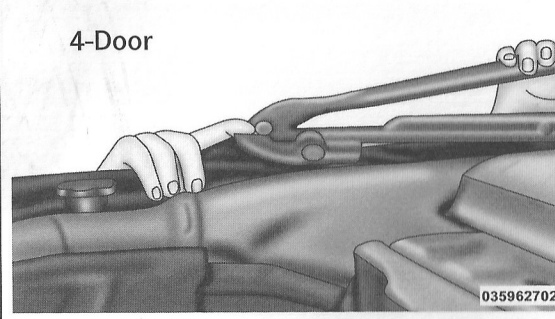

**7** Open swing gate and lower top, ensuring that no parts overhang the side of the vehicle.

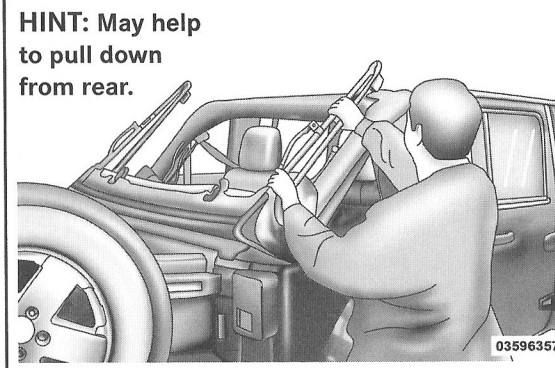

See other side for additional tips.

To close Soft Top, follow steps in reverse order.

Please see Owners Manual for complete details